

 15 400V $\frac{2,5^U}{4^E}$ r/f 24A

 LISTED
US Splicing wire connector
667 F
600V AWG 28-12

 Cu 1,6/2 Ø
JET 20A 300V

 400 V 32 A 2,5/4 mm²
Złączka uniwersalna
WAGO Elwag sp. z o.o., 50-505 Wrocław, ul. Piłkno 56a

To be sold only with installation instructions

Venta exclusivamente con instrucciones de instalación

A vendre uniquement avec instructions d'installation

 E 1440928

 E 1261120

 SSTL 1976299

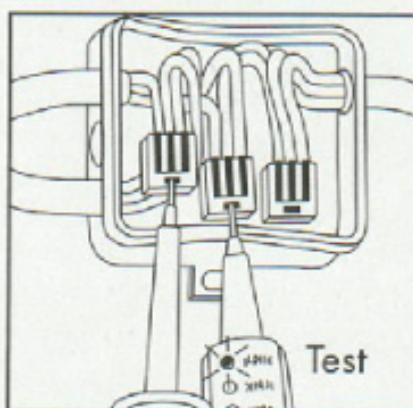
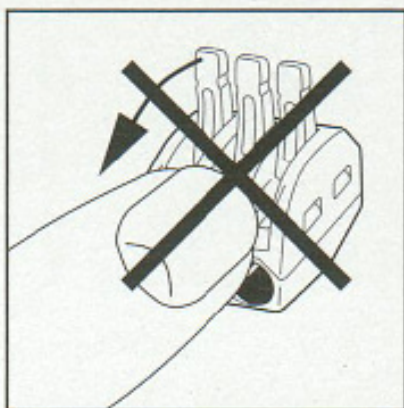
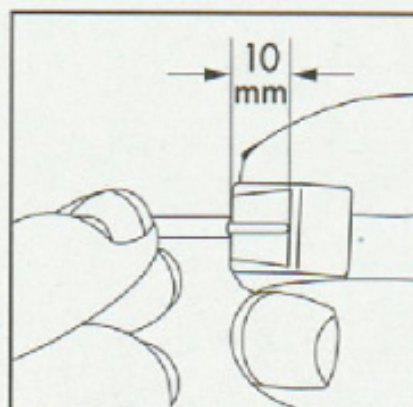
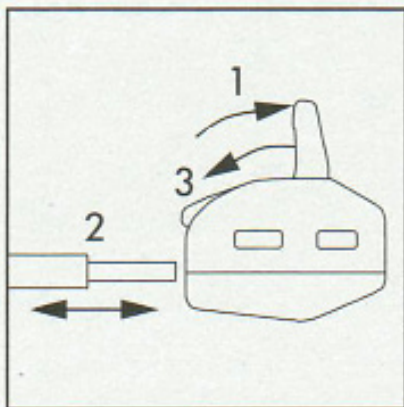

 15 400V $\frac{2,5^U}{4^E}$ r/f 24A

 LISTED
US Splicing wire connector
667 F
600V AWG 28-12

 Cu 1,6/2 Ø
JET 20A 300V

 400 V 32 A 2,5/4 mm²
Złączka uniwersalna
WAGO Elwag sp. z o.o., 50-505 Wrocław, ul. Piłkno 56a

To be sold only with installation instructions

Venta exclusivamente con instrucciones de instalación

A vendre uniquement avec instructions d'installation

 E 1440928

 E 1261120

 SSTL 1976299